



**Elektrik**  
Metal İmalat  
San. Tic. Ltd. Şti



**KABLO KANALLAR, MERDIVENLER VE AKSESUARLARIN KAPAKLARI**  
**CABLE TRAYS, LADDERS AND ACCESSORIES COVERS**

# INDEX

Kablo kanal, merdiven ve aksesuarlarının kapakları; standart olarak **pre-galvaniz (PG)** sacdan üretilmektedir. isteğe bağlı; **TS 914 EN ISO 1461 sıcak daldırma galvaniz (SDG)**, paslanmaz sacdan (**P**) ya da **elektrostatik toz boyalı (B)** olarak farklı metodlarda üretilebilmektedir.

Covers for cable trays, ladders and accessories are manufactured from **pre-galvanised (PG)** sheet metal as standard.optional; **TS 914 EN ISO 1461 hot dip galvanised (HDG)**, **stainless steel (SS)** sheet or It can be produced in different methods as **electrostatic powder coated** .



SAYFA / PAGE

KABLO KANAL ve MERDİVEN KAPAKLARI  
CABLE TRAY and LADDER COVERS

193

KABLO KANAL ve MERDİVEN KAPAKLARI  
CABLE TRAY and LADDER COVERS

194

Kanal ve Merdiven **90 Derece Dönüş Kapakları / 90 Degrees**, Cable Tray and Ladder Covers  
Kanal ve Merdiven **T Dönüş Kapakları T Bend**, Cable Tray and Ladder Covers  
Kanal ve Merdiven **Dörtlü Dönüş Kapakları Crossing**, Cable Tray and Ladder Covers

195

Kanal ve Merdiven **90 Derece Dönüş Kapakları / 90 Degrees**, Cable Tray and Ladder Covers  
Kanal ve Merdiven **T Dönüş Kapakları T Bend**, Cable Tray and Ladder Covers  
Kanal ve Merdiven **Dörtlü Dönüş Kapakları Crossing**, Cable Tray and Ladder Covers

196

Kanal ve Merdiven **90 Derece Dönüş Kapakları / 90 Degrees**, Cable Tray and Ladder Covers  
Kanal ve Merdiven **T Dönüş Kapakları T Bend**, Cable Tray and Ladder Covers  
Kanal ve Merdiven **Dörtlü Dönüş Kapakları Crossing**, Cable Tray and Ladder Covers

197

Kanal ve Merdiven **90 Derece Dönüş Kapakları / 90 Degrees**, Cable Tray and Ladder Covers  
Kanal ve Merdiven **T Dönüş Kapakları T Bend**, Cable Tray and Ladder Covers  
Kanal ve Merdiven **Dörtlü Dönüş Kapakları Crossing**, Cable Tray and Ladder Covers

198

Kanal ve Merdiven **135 Derece Dönüş Kapakları 135 Degrees**, Cable Tray and Ladder Covers  
Kanal ve Merdiven, **İç ve Dış Bükey Kapakları Cable Tray And Ladder Vertical Inside and Outside Bend Covers**

199

Z Redüksiyon Sağ- Sol **Z Reducer Left - Right**  
Z Redüksiyon Orta **Z Reducer Center**  
Sonlandırma **Ending Unit**

200

R300

R450

R600

Kod Code	Genişlik Width	Kalınlık Thickness	Mt/Kg
DM-K50.07	50	0,70	0,407
DM-K70.07	70	0,70	0,517
DM-K100.07	100	0,70	0,681
DM-K120.07	120	0,70	0,791
DM-K150.07	150	0,70	0,956
DM-K200.07	200	0,70	1,231

Kod Code	Genişlik Width	Kalınlık Thickness	Mt/Kg
DM-K50.08	50	0,80	0,465
DM-K70.08	70	0,80	0,590
DM-K100.08	100	0,80	0,779
DM-K120.08	120	0,80	0,904
DM-K150.08	150	0,80	1,093
DM-K200.08	200	0,80	1,407
DM-K250.08	250	0,80	1,721
DM-K300.08	300	0,80	2,035

Kod Code	Genişlik Width	Kalınlık Thickness	Mt/Kg
DM-K50.09	50	0,90	0,523
DM-K70.09	70	0,90	0,664
DM-K100.09	100	0,90	0,876
DM-K120.09	120	0,90	1,017
DM-K150.09	150	0,90	1,229
DM-K200.09	200	0,90	1,583
DM-K250.09	250	0,90	1,936
DM-K300.09	300	0,90	2,289

Kod Code	Genişlik Width	Kalınlık Thickness	Mt/Kg
DM-K50.10	50	1,00	0,581
DM-K70.10	70	1,00	0,738
DM-K100.10	100	1,00	0,973
DM-K120.10	120	1,00	1,130
DM-K150.10	150	1,00	1,366
DM-K200.10	200	1,00	1,758
DM-K250.10	250	1,00	2,151
DM-K300.10	300	1,00	2,543
DM-K400.10	400	1,00	3,328
DM-K500.10	500	1,00	4,113
DM-K600.10	600	1,00	4,898

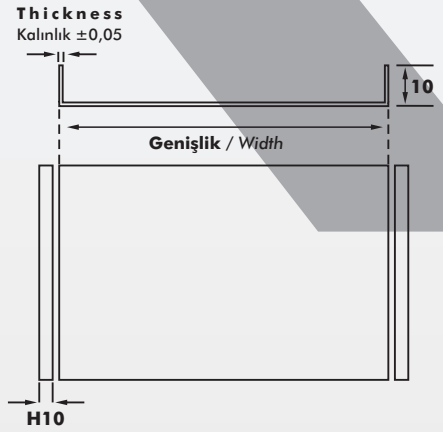
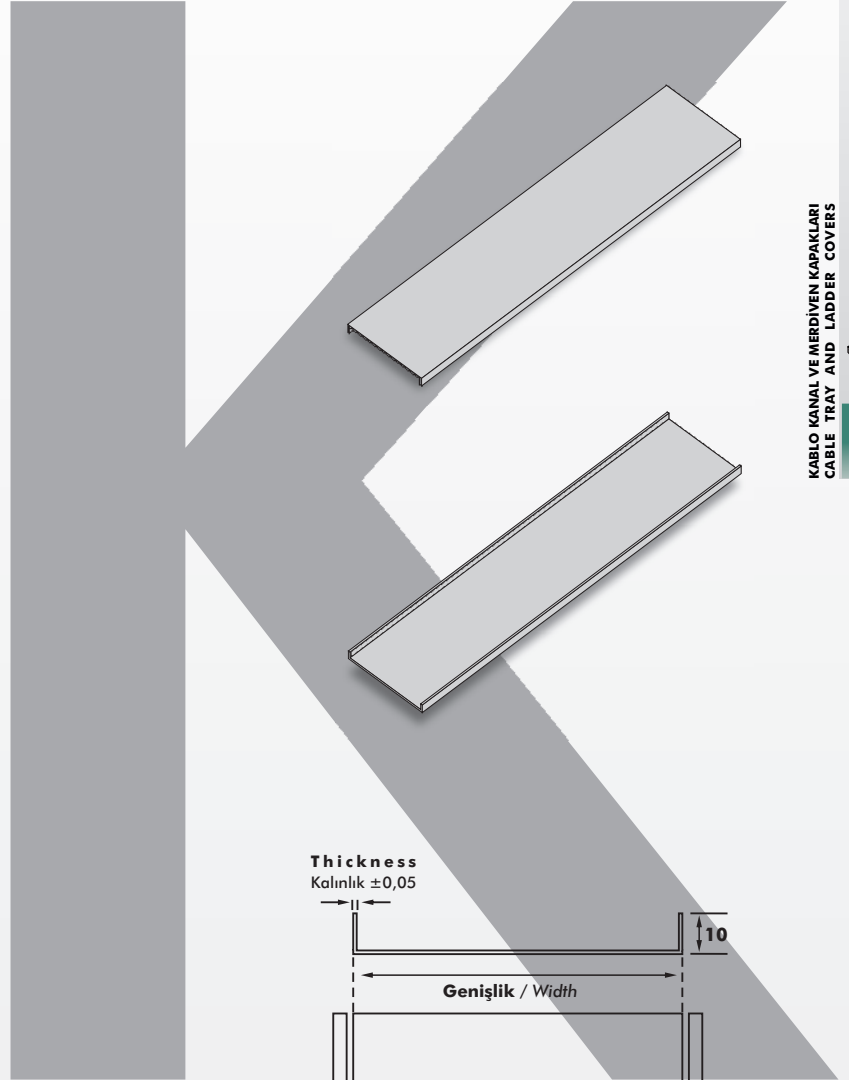

Kapaklar standart 2500mm uzunlukta üretilmektedir.  
Covers are produced in standard length of 2500mm.

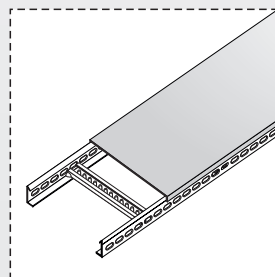
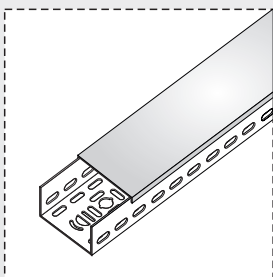

★ Ölçüler mm'dir ve ölçülerin toleransı  $\pm 3$  mm'dir.  
Belirtilen ağırlıklar kesim ağırlıklarıdır.  
Metrik 8 avata ve somun kullanımına uygundur.

★ The dimensions are in mm and the tolerance of the dimensions is  $\pm 3$  mm.  
Indicated weights are the weights before fabrication.  
Convenient for M8 bolt and nut usage.

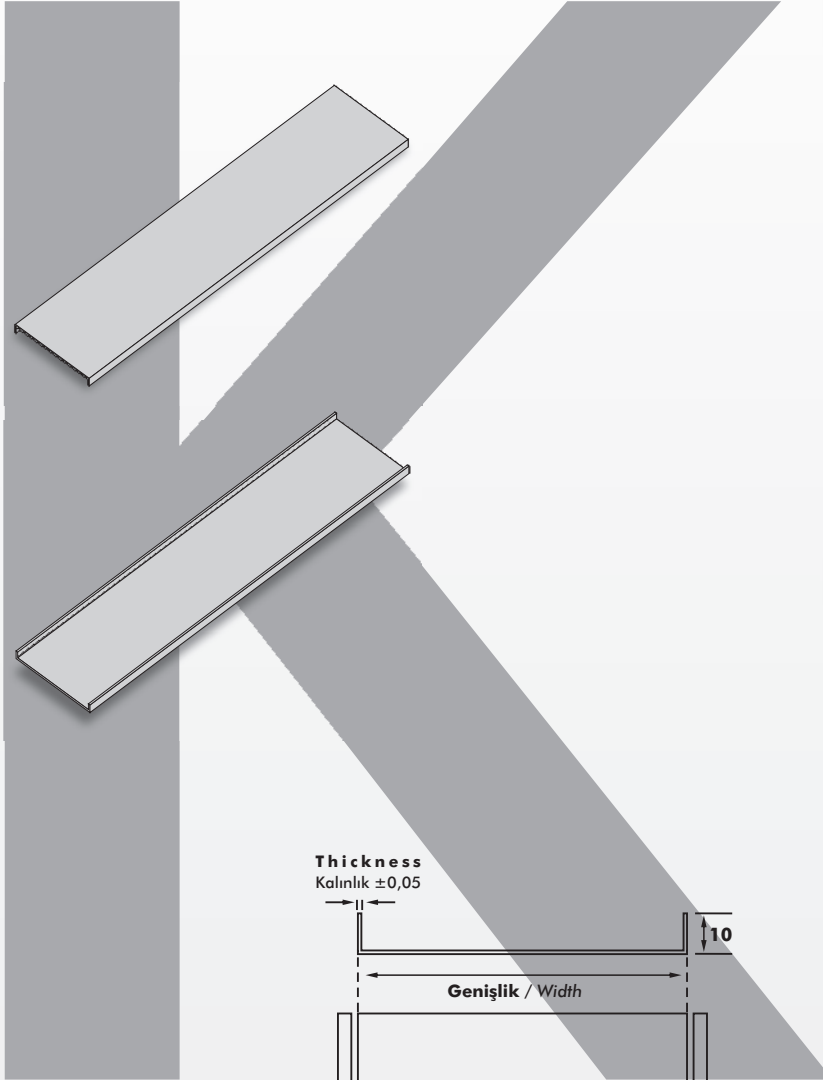

Kapaklar standart 2500mm uzunlukta üretilmektedir.  
Covers are produced in standard length of 2500mm.

Kod Code	Genişlik Width	Kalınlık Thickness	Mt/Kg
DM-K50.12	50	1,20	0,697
DM-K70.12	70	1,20	0,885
DM-K100.12	100	1,20	1,168
DM-K120.12	120	1,20	1,356
DM-K150.12	150	1,20	1,639
DM-K200.12	200	1,20	2,110
DM-K250.12	250	1,20	2,581
DM-K300.12	300	1,20	3,052
DM-K400.12	400	1,20	3,994
DM-K500.12	500	1,20	4,936
DM-K600.12	600	1,20	5,878

Kod Code	Genişlik Width	Kalınlık Thickness	Mt/Kg
DM-K50.15	50	1,50	0,871
DM-K70.15	70	1,50	1,107
DM-K100.15	100	1,50	1,460
DM-K120.15	120	1,50	1,696
DM-K150.15	150	1,50	2,049
DM-K200.15	200	1,50	2,638
DM-K250.15	250	1,50	3,226
DM-K300.15	300	1,50	3,815
DM-K400.15	400	1,50	4,993
DM-K500.15	500	1,50	6,170
DM-K600.15	600	1,50	7,348

Kod Code	Genişlik Width	Kalınlık Thickness	Mt/Kg
DM-K50.20	50	2,00	1,046
DM-K70.20	70	2,00	1,328
DM-K100.20	100	2,00	1,752
DM-K120.20	120	2,00	2,035
DM-K150.20	150	2,00	2,459
DM-K200.20	200	2,00	3,165
DM-K250.20	250	2,00	3,872
DM-K300.20	300	2,00	4,578
DM-K400.20	400	2,00	5,991
DM-K500.20	500	2,00	7,404
DM-K600.20	600	2,00	8,817

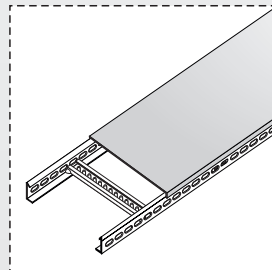
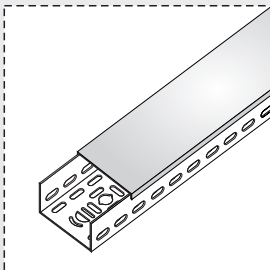

★ Ölçüler mm'dir ve ölçülerin toleransı  $\pm 3$  mm.'dir.  
Belirtilen ağırlıklar kesim ağırlıklarıdır.  
Metrik 8 civata ve somun kullanımına uygundur.

★ The dimensions are in mm and the tolerance of the dimensions is  $\pm 3$  mm.  
Indicated weights are the weights before fabrication.  
Convenient for M8 bolt and nut usage.

Kod Code	Genişlik Width	Kalınlık Thickness	Ad./ Kg Pcs. / Kg
DM-YDK50	55	1,20	0,124
DM-YDK70	75	1,20	0,173
DM-YDK100	105	1,20	0,260
DM-YDK120	125	1,20	0,328
DM-YDK150	155	1,20	0,444
DM-YDK200	205	1,20	0,675
DM-YDK250	255	1,20	0,953
DM-YDK300	305	1,50	1,597
DM-YDK400	405	1,50	2,586
DM-YDK500	505	1,50	3,811
DM-YDK600	605	1,50	5,271

# YDK

Kod Code	Genişlik Width	Kalınlık Thickness	Ad./ Kg Pcs. / Kg
DM-TDK50	55	1,20	0,137
DM-TDK70	75	1,20	0,135
DM-TDK100	105	1,20	0,217
DM-TDK120	125	1,20	0,281
DM-TDK150	155	1,20	0,391
DM-TDK200	205	1,20	0,612
DM-TDK250	255	1,20	0,881
DM-TDK300	305	1,50	1,495
DM-TDK400	405	1,50	2,461
DM-TDK500	505	1,50	3,662
DM-TDK600	605	1,50	5,099

# TDK

Kod Code	Genişlik Width	Kalınlık Thickness	Ad./ Kg Pcs. / Kg
DM-DDK50	55	1,20	0,249
DM-DDK70	75	1,20	0,227
DM-DDK100	105	1,20	0,329
DM-DDK120	125	1,20	0,406
DM-DDK150	155	1,20	0,536
DM-DDK200	205	1,20	0,790
DM-DDK250	255	1,20	1,092
DM-DDK300	305	1,50	1,800
DM-DDK400	405	1,50	2,848
DM-DDK500	505	1,50	4,132
DM-DDK600	605	1,50	5,651

★ Ölçüler mm'dir ve ölçülerin toleransı  $\pm 3$  mm.'dir. Belirtilen ağırlıklar kesim ağırlıklarıdır. Metrik 8 civata ve somun kullanımına uygundur.

★ The dimensions are in mm and the tolerance of the dimensions is  $\pm 3$  mm. Indicated weights are the weights before fabrication. Convenient for M8 bolt and nut usage.

### Kanal ve Merdiven 90 Derece Dönüş Kapakları

90 Degrees, Cable Tray and Ladder Covers

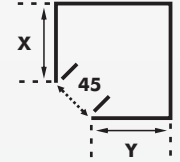
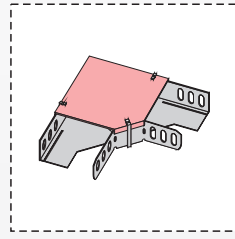
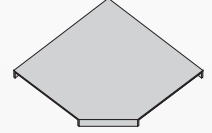
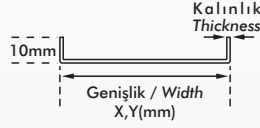

### Kanal ve Merdiven T Dönüş Kapakları

T Bend, Cable Tray and Ladder Covers

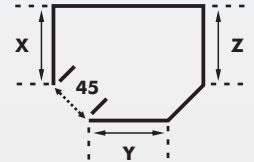
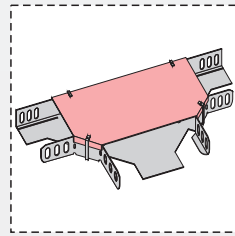
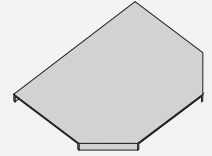
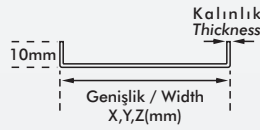

### Kanal ve Merdiven DörtlÜ Dönüş Kapakları

Crossing, Cable Tray and Ladder Covers

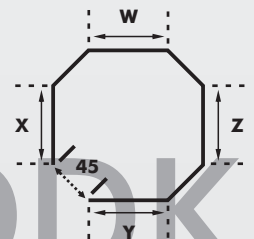
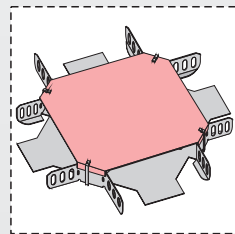
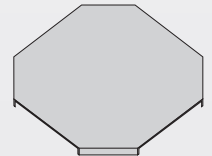

# DDK

## Kanal ve Merdiven 90 Derece Dönüş Kapakları

90 Degrees, Cable Tray and Ladder Covers

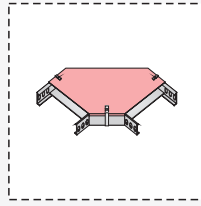
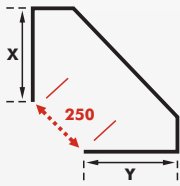
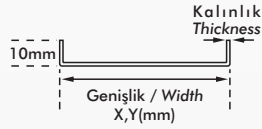

Kod Code	Genişlik Width	Kalınlık Thickness	Ad./ Kg Pcs. / Kg
DM-YDK50/300	55	1,20	0,198
DM-YDK70/300	75	1,20	0,268
DM-YDK100/300	105	1,20	0,384
DM-YDK120/300	125	1,20	0,468
DM-YDK150/300	155	1,20	0,604
DM-YDK200/300	205	1,20	0,860
DM-YDK250/300	255	1,20	1,150
DM-YDK300/300	305	1,50	1,844
DM-YDK400/300	405	1,50	2,786
DM-YDK500/300	505	1,50	3,908
DM-YDK600/300	605	1,50	5,202

YDK

## Kanal ve Merdiven T Dönüş Kapakları

T Bend, Cable Tray and Ladder Covers

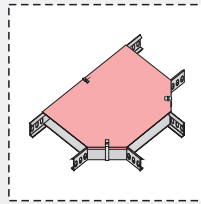
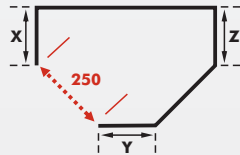
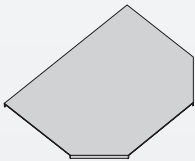

Kod Code	Genişlik Width	Kalınlık Thickness	Ad./ Kg Pcs. / Kg
DM-TDK50/300	55	1,20	0,658
DM-TDK70/300	75	1,20	0,786
DM-TDK100/300	105	1,20	0,992
DM-TDK120/300	125	1,20	1,139
DM-TDK150/300	155	1,20	1,373
DM-TDK200/300	205	1,20	1,876
DM-TDK250/300	255	1,20	2,276
DM-TDK300/300	305	1,50	3,498
DM-TDK400/300	405	1,50	4,980
DM-TDK500/300	505	1,50	6,698
DM-TDK600/300	605	1,50	8,651

TDK

## Kanal ve Merdiven Dörtlü Dönüş Kapakları

Crossing, Cable Tray and Ladder Covers

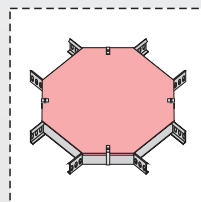
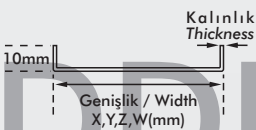
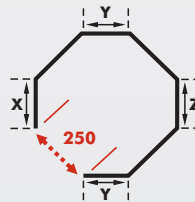
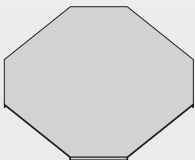

Kod Code	Genişlik Width	Kalınlık Thickness	Ad./ Kg Pcs. / Kg
DM-DDK50/300	55	1,20	0,362
DM-DDK70/300	75	1,20	0,520
DM-DDK100/300	105	1,20	0,771
DM-DDK120/300	125	1,20	0,948
DM-DDK150/300	155	1,20	1,227
DM-DDK200/300	205	1,20	1,806
DM-DDK250/300	255	1,20	2,281
DM-DDK300/300	305	1,50	3,598
DM-DDK400/300	405	1,50	5,268
DM-DDK500/300	505	1,50	7,173
DM-DDK600/300	605	1,50	9,315

★ Ölçüler mm'dir ve ölçülerin toleransı  $\pm 3$  mm'dir. Belirtilen ağırlıklar kesim ağırlıklarıdır. Metrik 8 cıvata ve somun kullanımına uygundur.

★ The dimensions are in mm and the tolerance of the dimensions is  $\pm 3$  mm. Indicated weights are the weights before fabrication. Convenient for M8 bolt and nut usage.

DDK R300

Kod Code	Genişlik Width	Kalınlık Thickness	Ad./ Kg Pcs. / Kg
DM-YDK50/450	55	1,20	0,275
DM-YDK70/450	75	1,20	0,367
DM-YDK100/450	105	1,20	0,516
DM-YDK120/450	125	1,20	0,622
DM-YDK150/450	155	1,20	0,792
DM-YDK200/450	205	1,20	1,102
DM-YDK250/450	255	1,20	1,447
DM-YDK300/450	305	1,50	2,285
DM-YDK400/450	405	1,50	3,364
DM-YDK500/450	505	1,50	4,624
DM-YDK600/450	605	1,50	6,057

# YDK

Kod Code	Genişlik Width	Kalınlık Thickness	Ad./ Kg Pcs. / Kg
DM-TDK50/450	55	1,20	1,151
DM-TDK70/450	75	1,20	1,325
DM-TDK100/450	105	1,20	1,602
DM-TDK120/450	125	1,20	1,795
DM-TDK150/450	155	1,20	2,099
DM-TDK200/450	205	1,20	2,735
DM-TDK250/450	255	1,20	3,236
DM-TDK300/450	305	1,50	4,844
DM-TDK400/450	405	1,50	6,619
DM-TDK500/450	505	1,50	8,629
DM-TDK600/450	605	1,50	10,874

# TDK

Kod Code	Genişlik Width	Kalınlık Thickness	Ad./ Kg Pcs. / Kg
DM-DDK50/450	55	1,20	0,518
DM-DDK70/450	75	1,20	0,738
DM-DDK100/450	105	1,20	1,083
DM-DDK120/450	125	1,20	1,322
DM-DDK150/450	155	1,20	1,695
DM-DDK200/450	205	1,20	2,429
DM-DDK250/450	255	1,20	3,060
DM-DDK300/450	305	1,50	4,767
DM-DDK400/450	405	1,50	6,826
DM-DDK500/450	505	1,50	9,122
DM-DDK600/450	605	1,50	11,653

★ Ölçüler mm'dir ve ölçülerin toleransı  $\pm 3$  mm.'dir. Belirtilen ağırlıklar kesim ağırlıklarıdır. Metrik 8 cıvata ve somun kullanımına uygundur.

★ The dimensions are in mm and the tolerance of the dimensions is  $\pm 3$  mm. Indicated weights are the weights before fabrication. Convenient for M8 bolt and nut usage.

### Kanal ve Merdiven 90 Derece Dönüş Kapakları

90 Degrees, Cable Tray and Ladder Covers

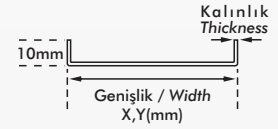
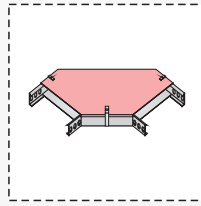
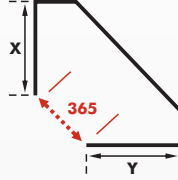

### Kanal ve Merdiven T Dönüş Kapakları

T Bend, Cable Tray and Ladder Covers

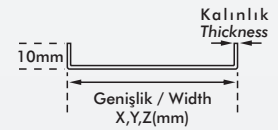
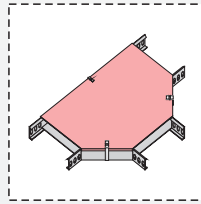
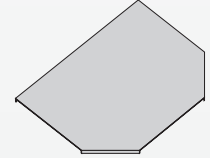
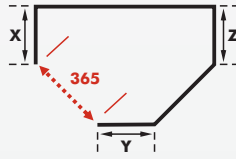

### Kanal ve Merdiven Dörtlü Dönüş Kapakları

Crossing, Cable Tray and Ladder Covers

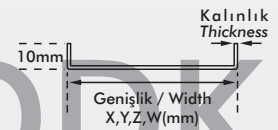
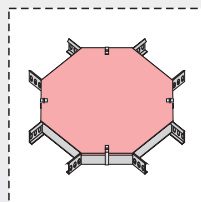
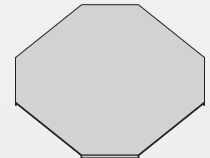
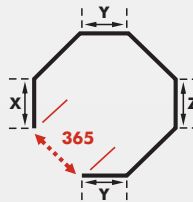

## Kanal ve Merdiven 90 Derece Dönüş Kapakları

90 Degrees, Cable Tray and Ladder Covers

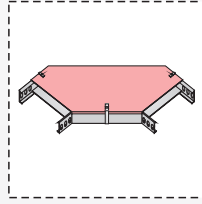
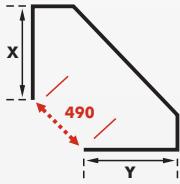
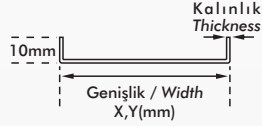

Kod Code	Genişlik Width	Kalınlık Thickness	Ad./ Kg Pcs. / Kg
DM-YDK50/600	55	1,20	0,359
DM-YDK70/600	75	1,20	0,367
DM-YDK100/600	105	1,20	0,516
DM-YDK120/600	125	1,20	0,622
DM-YDK150/600	155	1,20	0,792
DM-YDK200/600	205	1,20	1,102
DM-YDK250/600	255	1,20	1,447
DM-YDK300/600	305	1,50	2,285
DM-YDK400/600	405	1,50	3,364
DM-YDK500/600	505	1,50	4,624
DM-YDK600/600	605	1,50	6,057

YDK

## Kanal ve Merdiven T Dönüş Kapakları

T Bend, Cable Tray and Ladder Covers

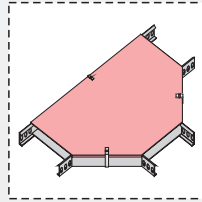
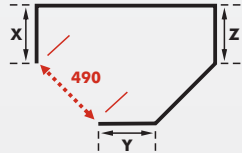
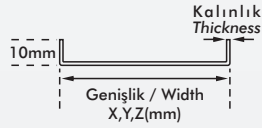
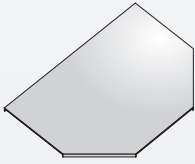

Kod Code	Genişlik Width	Kalınlık Thickness	Ad./ Kg Pcs. / Kg
DM-TDK50/600	55	1,20	1,825
DM-TDK70/600	75	1,20	2,050
DM-TDK100/600	105	1,20	2,402
DM-TDK120/600	125	1,20	2,646
DM-TDK150/600	155	1,20	3,026
DM-TDK200/600	205	1,20	3,804
DM-TDK250/600	255	1,20	4,415
DM-TDK300/600	305	1,50	6,474
DM-TDK400/600	405	1,50	8,564
DM-TDK500/600	505	1,50	10,888
DM-TDK600/600	605	1,50	13,449

TDK

## Kanal ve Merdiven DörtlÜ Dönüş Kapakları

Crossing, Cable Tray and Ladder Covers

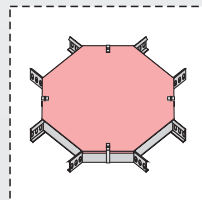
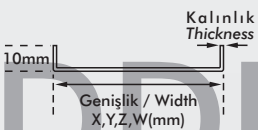
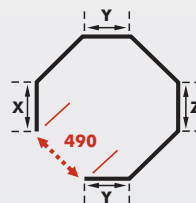
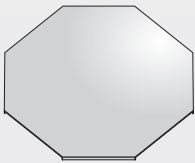

Kod Code	Genişlik Width	Kalınlık Thickness	Ad./ Kg Pcs. / Kg
DM-DDK50/600	55	1,20	0,686
DM-DDK70/600	75	1,20	0,973
DM-DDK100/600	105	1,20	1,418
DM-DDK120/600	125	1,20	1,725
DM-DDK150/600	155	1,20	2,198
DM-DDK200/600	205	1,20	3,101
DM-DDK250/600	255	1,20	3,899
DM-DDK300/600	305	1,50	6,025
DM-DDK400/600	405	1,50	8,505
DM-DDK500/600	505	1,50	11,220
DM-DDK600/600	605	1,50	14,170

★ Ölçüler mm'dir ve ölçülerin toleransı  $\pm 3$  mm'dir. Belirtilen ağırlıklar kesim ağırlıklarıdır. Metrik 8 cıvata ve somun kullanımına uygundur.

★ The dimensions are in mm and the tolerance of the dimensions is  $\pm 3$  mm. Indicated weights are the weights before fabrication. Convenient for M8 bolt and nut usage.

DDK R600



Kod Code	Genişlik Width	Kalınlık Thickness	Ad./ Kg Pcs. / Kg
DM-YDK50/135	55	1,20	0,051
DM-YDK70/135	75	1,20	0,090
DM-YDK100/135	105	1,20	0,176
DM-YDK120/135	125	1,20	0,245
DM-YDK150/135	155	1,20	0,374
DM-YDK200/135	205	1,20	0,647
DM-YDK250/135	255	1,20	0,997
DM-YDK300/135	305	1,50	1,774
DM-YDK400/135	405	1,50	3,105
DM-YDK500/135	505	1,50	4,822
DM-YDK600/135	605	1,50	6,910

### Kanal ve Merdiven 135 Derece Dönüş Kapakları

135 Degrees, Cable Tray and Ladder Covers

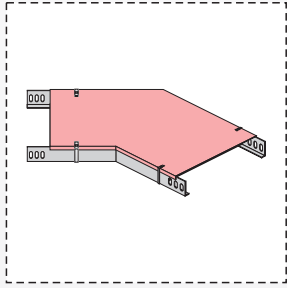
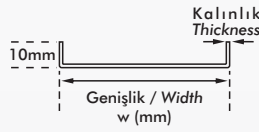
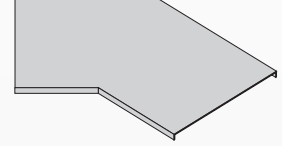

# YDK135

Kod Code	Genişlik Width	Kalınlık Thickness	Ad./ Kg Pcs. / Kg
DM-BK50	55	1,20	0,465
DM-BK70	75	1,20	0,590
DM-BK100	105	1,20	0,779
DM-BK120	125	1,20	0,904
DM-BK150	155	1,20	1,311
DM-BK200	205	1,20	1,688
DM-BK250	255	1,20	2,065
DM-BK300	305	1,50	3,052
DM-BK400	405	1,50	3,994
DM-BK500	505	1,50	4,936
DM-BK600	605	1,50	5,878

### Kanal ve Merdiven, İç ve Dış Bükey Kapakları

Cable Tray And Ladder Vertical Inside And Outside Bend Covers

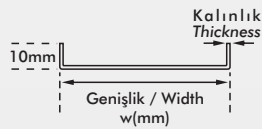
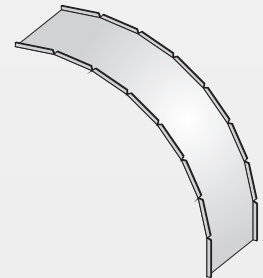
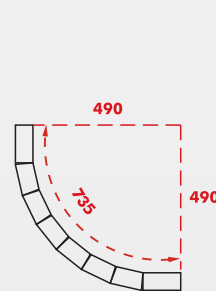
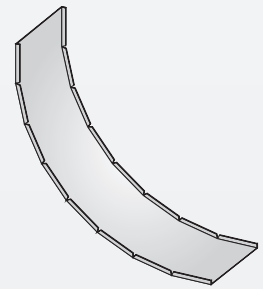
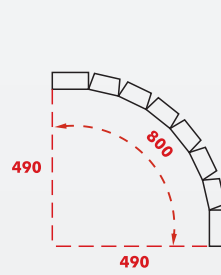

★ Ölçüler mm'dir ve ölçülerin toleransı  $\pm 3$  mm.'dir. Belirtilen ağırlıklar kesim ağırlıklarıdır. Metrik 8 civata ve somun kullanımına uygundur.

★ The dimensions are in mm and the tolerance of the dimensions is  $\pm 3$  mm. Indicated weights are the weights before fabrication. Convenient for M8 bolt and nut usage.

# BK

## Dikey T Kapakları (Ortadan)

## Vertical T Covers (Center)

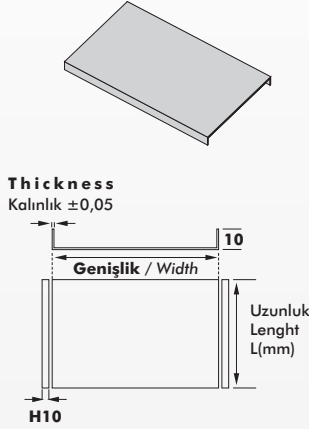

Kanal - Merdiven Yüksekliği Tray and Ladder Height (h)	Uzunluk Length (L)
40	380
50	390
60	400
75	415
100	440
125	465
150	490

Kod Code	Genişlik Width (w)	Kalınlık Thickness	Ad./ Kg Pcs. / Kg
DM-DTOK100	105	1,20	0,995
DM-DTOK120	125	1,20	1,096
DM-DTOK150	155	1,20	1,252
DM-DTOK200	205	1,20	1,524
DM-DTOK250	255	1,20	1,811
DM-DTOK300	305	1,50	2,642
DM-DTOK400	405	1,50	3,457
DM-DTOK500	505	1,50	4,350
DM-DTOK600	605	1,50	5,319

DTOK

## Dikey T Kapakları (Duvardan)

## Vertical T Covers (Wall)

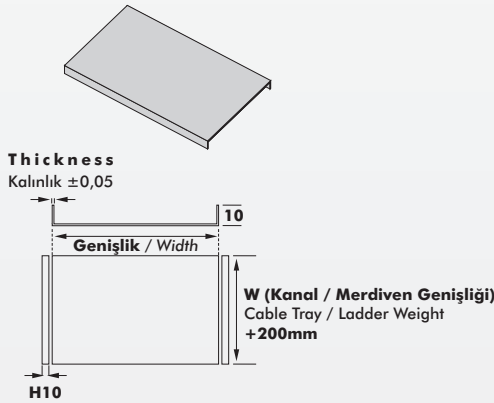

Kod Code	Genişlik Width	Kalınlık Thickness	Ad./ Kg Pcs. / Kg
DM-DTKD100	105	1,20	0,467
DM-DTKD120	125	1,20	0,543
DM-DTKD150	155	1,20	0,656
DM-DTKD200	205	1,20	0,844
DM-DTKD250	255	1,20	1,032
DM-DTKD300	305	1,50	1,526
DM-DTKD400	405	1,50	1,997
DM-DTKD500	505	1,50	2,468
DM-DTKD600	605	1,50	2,939

DTDK

## Kapak Tutucular

## Cover Clamps

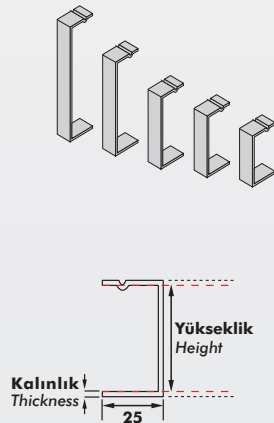

Kod Code	Yükseklik Height	Kalınlık Thickness	Ad./ Kg Pcs. / Kg
DM-KT40	42	1,50	0,016
DM-KT50	52	1,50	0,018
DM-KT60	62	1,50	0,020
DM-KT75	77	1,50	0,022
DM-KT100	102	1,50	0,027
DM-KT125	127	1,50	0,031
DM-KT150	152	1,50	0,036

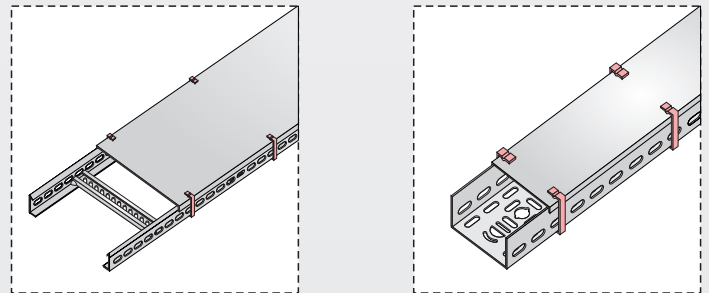

KT

★ Ölçüler mm'dir ve ölçülerin toleransı  $\pm 3$  mm.'dir.  
Belirtilen ağırlıklar kesim ağırlıklarıdır.  
Metrik 8 cıvata ve somun kullanımına uygundur.

★ The dimensions are in mm and the tolerance of the dimensions is  $\pm 3$  mm.  
Indicated weights are the weights before fabrication.  
Convenient for M8 bolt and nut usage.